



MARCH 1998

IC620A-F

IC623A-M

IC620A-M

IC624A-F

IC623A-F

IC624A-M

RS-232/485 Converter

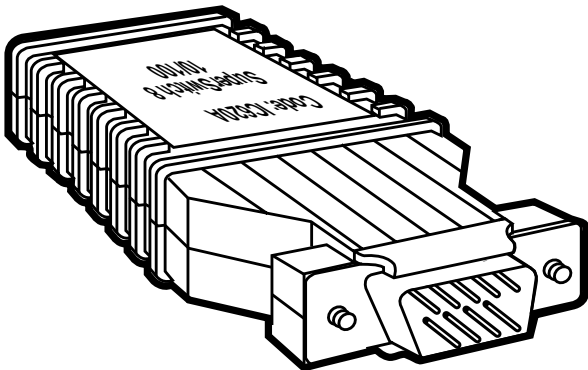

CUSTOMER SUPPORT INFORMATION

Order **toll-free** in the U.S. 24 hours, 7 A.M. Monday to midnight Friday: **877-877-BBOX**
FREE technical support, 24 hours a day, 7 days a week: Call **724-746-5500** or fax **724-746-0746**
Mail order: **Black Box Corporation**, 1000 Park Drive, Lawrence, PA 15055-1018
Web site: www.blackbox.com • E-mail: info@blackbox.com

**FEDERAL COMMUNICATIONS COMMISSION
AND
INDUSTRY CANADA
RADIO FREQUENCY INTERFERENCE STATEMENTS**

This equipment generates, uses, and can radiate radio frequency energy and if not installed and used properly, that is, in strict accordance with the manufacturer's instructions, may cause interference to radio communication. It has been tested and found to comply with the limits for a Class A computing device in accordance with the specifications in Subpart J of Part 15 of FCC rules, which are designed to provide reasonable protection against such interference when the equipment is operated in a commercial environment. Operation of this equipment in a residential area is likely to cause interference, in which case the user at his own expense will be required to take whatever measures may be necessary to correct the interference.

Changes or modifications not expressly approved by the party responsible for compliance could void the user's authority to operate the equipment.

This digital apparatus does not exceed the Class A limits for radio noise emission from digital apparatus set out in the Radio Interference Regulation of Industry Canada.

Le présent appareil numérique n'émet pas de bruits radioélectriques dépassant les limites applicables aux appareils numériques de classe A prescrites dans le Règlement sur le brouillage radioélectrique publié par Industrie Canada.

This unit is  certified.

**NORMAS OFICIALES MEXICANAS (NOM)
ELECTRICAL SAFETY STATEMENT**

INSTRUCCIONES DE SEGURIDAD

1. Todas las instrucciones de seguridad y operación deberán ser leídas antes de que el aparato eléctrico sea operado.
2. Las instrucciones de seguridad y operación deberán ser guardadas para referencia futura.
3. Todas las advertencias en el aparato eléctrico y en sus instrucciones de operación deben ser respetadas.
4. Todas las instrucciones de operación y uso deben ser seguidas.
5. El aparato eléctrico no deberá ser usado cerca del agua—por ejemplo, cerca de la tina de baño, lavabo, sótano mojado o cerca de una alberca, etc..
6. El aparato eléctrico debe ser usado únicamente con carritos o pedestales que sean recomendados por el fabricante.
7. El aparato eléctrico debe ser montado a la pared o al techo sólo como sea recomendado por el fabricante.
8. Servicio—El usuario no debe intentar dar servicio al equipo eléctrico más allá a lo descrito en las instrucciones de operación. Todo otro servicio deberá ser referido a personal de servicio calificado.
9. El aparato eléctrico debe ser situado de tal manera que su posición no interfiera su uso. La colocación del aparato eléctrico sobre una cama, sofá, alfombra o superficie similar puede bloquea la ventilación, no se debe colocar en libreros o gabinetes que impidan el flujo de aire por los orificios de ventilación.

10. El equipo eléctrico deber ser situado fuera del alcance de fuentes de calor como radiadores, registros de calor, estufas u otros aparatos (incluyendo amplificadores) que producen calor.
11. El aparato eléctrico deberá ser conectado a una fuente de poder sólo del tipo descrito en el instructivo de operación, o como se indique en el aparato.
12. Precaución debe ser tomada de tal manera que la tierra fisica y la polarización del equipo no sea eliminada.
13. Los cables de la fuente de poder deben ser guiados de tal manera que no sean pisados ni pellizcados por objetos colocados sobre o contra ellos, poniendo particular atención a los contactos y receptáculos donde salen del aparato.
14. El equipo eléctrico debe ser limpiado únicamente de acuerdo a las recomendaciones del fabricante.
15. En caso de existir, una antena externa deberá ser localizada lejos de las líneas de energía.
16. El cable de corriente deberá ser desconectado del cuando el equipo no sea usado por un largo periodo de tiempo.
17. Cuidado debe ser tomado de tal manera que objetos líquidos no sean derramados sobre la cubierta u orificios de ventilación.
18. Servicio por personal calificado deberá ser provisto cuando:
 - A: El cable de poder o el contacto ha sido dañado; u
 - B: Objetos han caído o líquido ha sido derramado dentro del aparato; o
 - C: El aparato ha sido expuesto a la lluvia; o
 - D: El aparato parece no operar normalmente o muestra un cambio en su desempeño; o
 - E: El aparato ha sido tirado o su cubierta ha sido dañada.

TRADEMARKS

Product names mentioned in this manual may be trademarks or registered trademarks of their respective companies and are hereby acknowledged.

CONTENTS

1. Specifications	6
2. Introduction	8
2.1 Description	8
2.2 Features	9
3. Configuration	11
3.1 Accessing the DIP Switches	11
3.1.1 DIP Switch S1 Settings	16
3.1.2 DIP Switch S2 Settings	18
3.2 Typical Applications	20
4. Installation	24
4.1 Twisted-Pair Connection	22
4.1.1 Twisted-Pair Connections Using Terminal Blocks	23
4.1.2 Twisted-Pair Connection Using RJ-11 or RJ-45	29
4.2 Wiring for Multipoint Circuits	31
4.3 Connection to the EIA/TIA-574 Interface	33
4.4 Operating the Converter	34
Appendix: EIA/TIA-574 Interface	35

1. Specifications

Transmission Format — Asynchronous

Data Rate — Up to 115,200 bps

Range — Up to 9 miles (14.4 km)

Serial Interface — EIA/TIA-574 standard RS-232 DCE

Connectors — *IC620A-F*: (1) DB9 female, (1) 5-position terminal block,
IC620A-M: (1) DB9 male, (1) 5-position terminal block;
IC623A-F: (1) DB9 female, (1) RJ-11 female,
IC623A-M: (1) DB9 male, (1) RJ-11 female;
IC624A-F: (1) DB9 female, (1) RJ-45 female,
IC624A-M: (1) DB9 male, (1) RJ-45 female

Transmit Line — 2-wire or 4-wire unconditioned, unshielded, solid core, twisted pair

Transmit Mode — 4-wire, full- or half-duplex;
2-wire half-duplex

Control Signals — DSR turns ON immediately after the terminal raises DTR; DCD turns ON after recognizing the receive signal from the line;

CTS turns ON after the terminal raises RTS

RTS/CTS Delay — 8 msec or “no delay”

Carrier — The carrier is switch-selected either continuous operation or switched operation, controlled by RTS

Surge Protection — 600 W power dissipation at 1 ms

Temperature — 32 to 122°F (0 to 50°C)

Humidity — 5 to 95%, noncondensing

Maximum Altitude — 10,000 ft. (304.8 m)

MTBF — 209,384 hours

Power — Draws operating power from EIA/TIA-574 data and control signals; no AC power or batteries required. If necessary, 6 to 12 VDC can be applied to pin 9 of the EIA/TIA-574 interface

Size — 2.5"H x 1.2"W x 0.75"D (6.4 x 3.1 x 1.9 cm)

Shipping Weight — 1 lb. (0.5 kg)

2. Introduction

2.1 Description

The RS-232/485 Converter (IC620A) is an ultra-miniature interface converter. Requiring no AC power or batteries for operation, the Converter supports asynchronous communication up to 115.2 Kbps over one or two unconditioned twisted pairs. Distances up to 15 miles (24 km) are attainable at lower data rates (1.2 Kbps, 19 AWG twisted pair).

The Converter can handle up to 31 terminal drops in a multipoint polling environment. For RS-485 applications that require hardware handshaking, the Converter passes one control signal in each direction (see the last bullet point in **Section 2.2** for an explanation). The Converter may be configured for high or low impedance, and the carrier may be set to “constantly on” or “controlled by RTS.” The unit can operate with or without “echo.” RTS/CTS delay may be set for “no delay” or “8 ms delay.”

There are three options for twisted-pair connection: terminal blocks with strain relief, RJ-11, or RJ-45. Silicon Avalanche Diodes provide 600 watts per wire of protection against harmful data-line transient surges.

Six models are available:

- DB9F/Term (IC620A-F)
- DB9M/Term (IC620A-M)
- DB9F/RJ-11 (IC623A-F)
- DB9M/RJ-11 (IC623A-M)
- DB9F/RJ-45 (IC624A-F)
- DB9F/RJ-45 (IC624A-M)

2.2 Features

- Operates asynchronously, point-to-point or multipoint, over 2 or 4 wires.
- Up to 31 multipoint device drops in a polling environment.
- Data rates up to 115.2 Kbps.
- Passes transmit and receive data, one control signal in each direction.
- No AC power or batteries required.
- Variable high/low impedance settings.
- Able to operate with or without “echo.”
- Carrier can be set as “constantly on” or “controlled by RTS.”

RS-232/485 CONVERTER

- Twisted-pair connection via strain relief, RJ-11, or RJ-45.
- Silicon Avalanche Diode surge protection.
- A Transmitter On signal received at the RS-485 RCV connection will cause DCD output at the RS-232 connector to assert High.

3. Configuration

The Converter is configured using two internal 4-position DIP switches. This section shows how to access the DIP switches, provides an overview of the factory-default settings, and describes all possible configuration options. For instructions on how to configure the Converter for specific applications, see **Section 3.2**.

3.1 Accessing the DIP Switches

The Converter has a main PC board and a daughter-board. DIP switch S1 is located on the underside of the main PC board (see **Figure 3-1**). DIP switch S2 is located on the top of the daughterboard (see **Figure 3-2**).

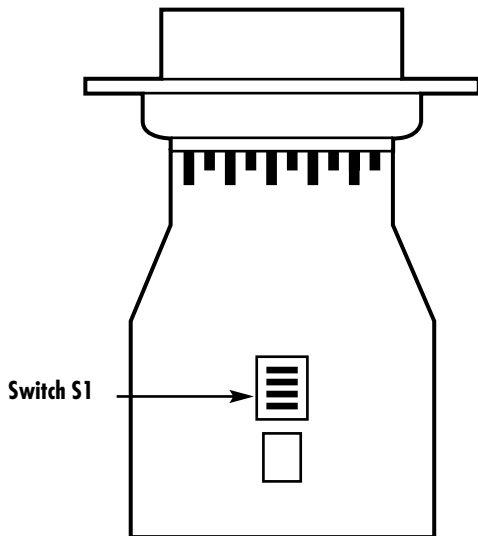

Figure 3-1. Underside of the Converter's main PC board, showing the location of DIP switch S1.

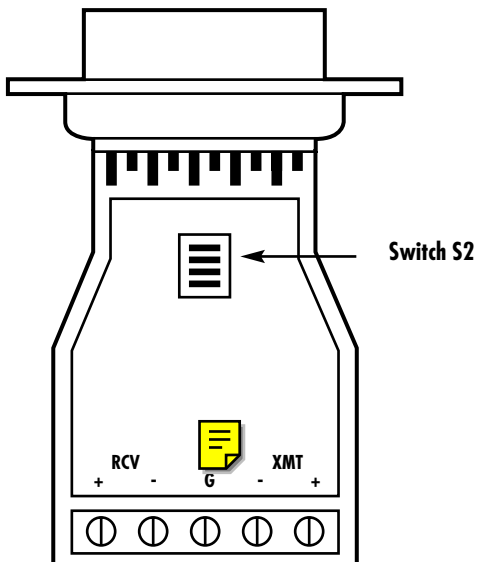

Figure 3-2. Top of the Converter's daughterboard, showing the location of DIP switch S2.

RS-232/485 CONVERTER

To access the Converter's internal PC boards, insert a small flat-blade screwdriver between the connector and the lip of the case and twist gently as shown in **Figure 3-3**.

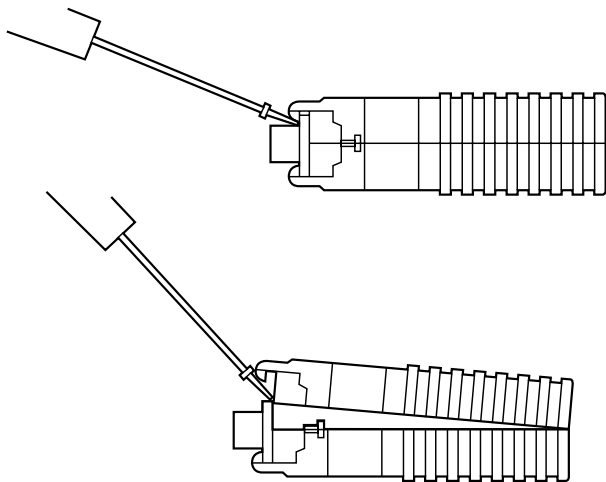

Figure 3-3. Opening the Converter's plastic case with a small screwdriver.

Both DIP switch S1 and S2 are marked with individual switch numbers 1 through 4. Use these numbers, and the “ON” designation to orient the switch properly (see **Figure 3-4**). Use a small screwdriver or similar instrument to set each individual switch.

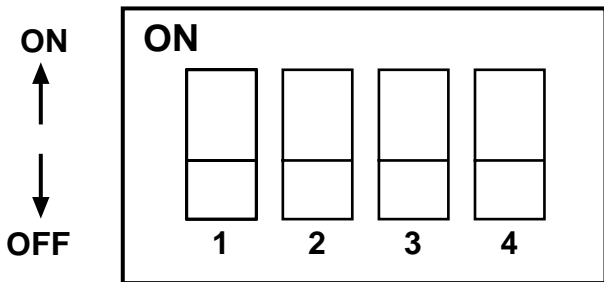

Figure 3-4. Close-up of DIP switches S1 and S2, showing ON/OFF orientation.

3.1.1 DIP SWITCH S1 SETTINGS

DIP switch S1 is used to configure receive impedance (termination), 2-wire/4-wire operation and “echo” enable/disable. **Table 3-1** shows the factory-default settings for switch S1. Following **Table 3-1** is a detailed description of each switch.

Table 3-1. Switch S1 Summary Table (factory defaults in bold)

Position	Function	OFF Position	ON Position
S1-1	RCV impedance (termination)	16 K ohms, typ.	120 ohms
S1-2*	2-wire/4-wire	4-wire	2-wire
S1-3*	2-wire/4-wire	4-wire	2-wire
S1-4	Echo Mode	Echo OFF	Echo ON

*Switches S1-2 and S1-3 should be switched simultaneously.

S1-1: Receive Impedance (Termination)

The setting for switch S1-1 selects the impedance of the input receiver. You may select either a “low” impedance of 120 ohms or a “high” impedance of 16 K ohms. By selecting the proper impedance for each drop, you can have up to 50 receivers in one application.

<u>S1-1</u>	<u>Setting</u>
On	Low (120 ohms)
Off	High (16 K ohms typical)

S1-2 and S1-3: 2-wire/4-wire Modes

Switches S1-2 and S1-3 are set together to determine whether the Converter is in 2-wire or 4-wire operating mode.

NOTE

2-wire mode is half-duplex only.

<u>S1-2</u>	<u>S1-3</u>	<u>Setting</u>
On	On	2-wire mode
Off	Off	4-wire mode

S1-4: Echo Mode

The setting for switch S1-4 determines whether the Converter echoes data back to the transmitting device (half-duplex mode only).

<u>S1-4</u>	<u>Setting</u>
On	Echo On
Off	Echo Off

3.1.2 DIP SWITCH S2 SETTINGS

DIP switch S2 is used to configure carrier control, RTS/CTS delay, and communication protocol. **Table 3-2** shows the factory-default settings for switch S2. Following **Table 3-2** is a detailed description of each individual switch.

Table 3-2. Switch S2 Summary Table (factory defaults in bold)

Position	Function	OFF Position	ON Position
S2-1	Carrier Control	Constantly ON	ON Position
S2-2	RTS/CTS Delay	No Delay	8 msec
S2-3*	"XMT Off" impedance	High	Intermediate
S2-4*	"XMT Off" impedance	High	Intermediate

*Switches S2-3 and S2-4 should be switched simultaneously.

S2-1: Carrier Control Method

The setting for S2-1 determines whether the carrier is “Constantly On” or “Controlled by RTS.” This allows for operation in switched carrier, multipoint, and/or hardware handshaking applications.

<u>S2-1</u>	<u>Setting</u>
On	Controlled by RTS
Off	Constantly On

NOTE

When in Controlled mode, RTS must go negative to turn off the Transmitter and enable the Receiver.

S2-2: RTS/CTS Delay

The setting for switch S2-2 determines the amount of delay between the time the Converter “sees” RTS and when it sends CTS.

NOTE

The RTS/CTS Delay setting should be based upon transmission timing.

<u>S2-2</u>	<u>Setting</u>
On	8 msec
Off	No delay

S2-3 and S2-4: “Transmit Off” Impedance

Switches S2-3 and S2-4 are set together to determine whether the receiving device “sees” the impedance of the Converter’s transmitter as being “high” or “intermediate” when the transmitter is turned off. The “intermediate” setting is useful in half-duplex environments where the receiving device does not respond well to the “high” setting.

<u>S2-3</u>	<u>S2-4</u>	<u>Setting</u>
On	On	Intermediate impedance
Off	Off	High impedance

3.2 Typical Applications

The Converter is commonly used in five types of applications:

- 4-wire/full-duplex/point-to-point
- 4-wire/half-duplex/point-to-point
- 2-wire/half-duplex/point-to-point
- 4-wire/multipoint
- 2-wire/multipoint

The switch settings generally needed to configure the Converter for these applications are shown in **Table 3-3**.

NOTE

Do not change switch settings until you have carefully read Section 3.1.

Table 3-3. Typical Converter Applications

Switch Settings	Point-to-Point			Multipoint	
	4W	4W HDX	2W	4W	2W
S1-1: Rcv impedance (Termination)	ON	ON	ON	Master—ON Slaves—OFF Last Slave—ON	
S1-2: 2-wire/4-wire	OFF	OFF	ON	OFF	ON
S1-3: 2-wire/4-wire	OFF	OFF	ON	OFF	ON
S1-4: Echo	OFF	OFF	OFF	OFF	OFF
S2-1: Carrier Control	OFF	ON	ON	Master—OFF Slaves—ON	ON
S2-2: RTS/CTS Delay	ON	ON	ON	OFF	ON
S2-3: "Xmt Off" imp.	OFF	OFF	OFF	OFF	OFF
S2-4: "Xmt Off" imp.	OFF	OFF	OFF	OFF	OFF

4. Installation

Once the Converter is properly configured, it is ready to connect to your system. This section tells you how to properly connect the Converter to the twisted-pair and EIA/TIA-574 interfaces, and how to operate the Converter.

4.1 Twisted-Pair Connection

The Converter supports 2-wire or 4-wire communication between two or more EIA/TIA-574 devices at data rates up to 115.2 Kbps. There is one essential requirement for installing the Converter:

To function properly, the Converter needs one or two twisted pairs of metallic wire. These pairs must be unconditioned dry metallic wire, between 19 and 26 AWG solid copper core, unshielded (the higher-number gauges may limit distance). Standard dialup telephone circuits that run through signal-equalization equipment are not acceptable.

For your convenience, the Converter is available with several different twisted-pair interfaces: RJ-11 jack, RJ-45 jack, and terminal blocks with strain relief. The Converter is also available with DB25 male or female connectors.

4.1.1 TWISTED-PAIR CONNECTIONS USING TERMINAL BLOCKS

If your application requires you to connect one or two pairs of bare wires to the Converter, you will need to open the case to access the terminal blocks. The following instructions tell you how to open the case, connect the bare wires to the terminal blocks, and fasten the strain-relief collar in place so the wires won't pull loose.

1. You should already have the case open for the configuration procedure. If not, see **Section 3.1**.
2. Strip the outer insulation from the twisted pair(s) about one inch from the end.

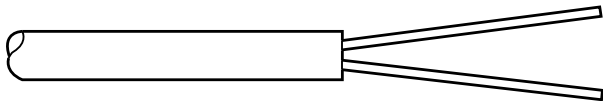

Figure 4-1. Stripping the outer insulation.

3. Strip the insulation on each of the twisted-pair wires about 1/8 inch.

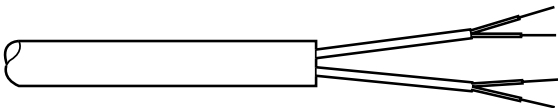

Figure 4-2. Stripping the insulation on the twisted-pair wires.

4. In a two-pair circuit, connect one pair of wires to XMT+ and XMT- (transmit positive and negative) on the terminal block, making careful note of which color is positive and which color is negative.
5. Connect the other pair of wires to RCV+ and RCV- (receive positive and negative) on the terminal block, again making careful note of which color is positive and which color is negative.

Ultimately, you will want to construct a two-pair crossover cable that makes a connection with the two Converters as shown in **Figure 4-3**.

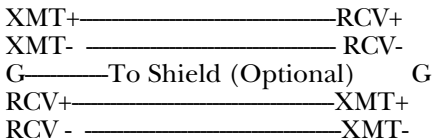

Figure 4-3. Two-Pair Crossover Cable.

6. In a single-pair circuit, use only the transmit (XMT) pair as shown in **Figure 4-4**.

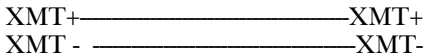

Figure 4-4. Transmit Pair.

NOTE

If there is a shield around the twisted-pair cable, it may be connected to “G” on the terminal block. To avoid ground loops, we recommend connecting the shield at the computer end only. A ground wire is not necessary for proper operation of the Converter.

7. When you finish connecting the wires to the terminal block, the assembly should resemble **Figure 4-5**.

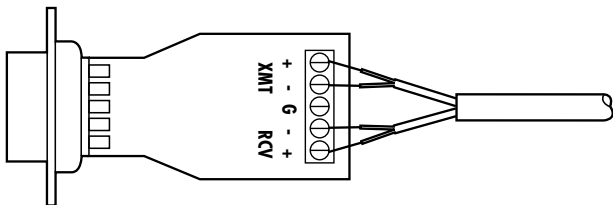

Figure 4-5. Wires connected to the terminal block.

8. Place the two halves of the strain-relief assembly on either side of the telephone wire and press together very lightly. Slide the assembly so that it is about two inches from the terminal posts and press together firmly. If your cable diameter is too small or too large for our strain relief, call for technical support.

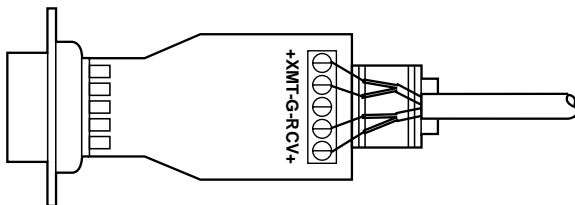

Figure 4-6. Installing the strain relief assembly.

9. Insert the strain-relief assembly with the wire going through it into the slot in the bottom half of the modem case and seat it into the recess in the case. (If the telephone wire is too thin to be held by the strain-relief assembly, you will need to order a different-sized strain relief. Call for technical support.)

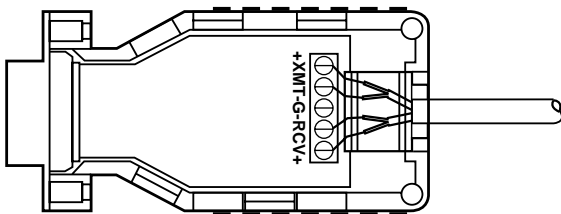

Figure 4-7. Completing the installation of the strain-relief assembly.

10. Bend the top of the case as necessary to place it over the strain-relief assembly. Do not snap the case together yet.

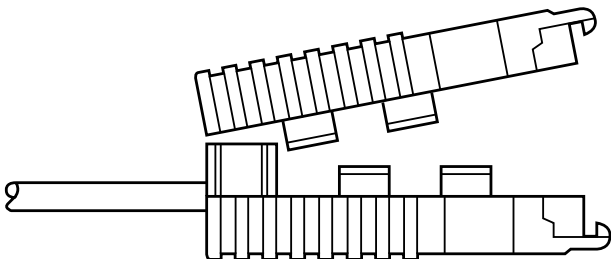

Figure 4-8. Closing the case.

11. Insert one captive screw through a saddle washer and then insert the captive screw, with the washer on it, through the hole in the DB25 end of the case. Snap that side of the case closed. Repeat the process for the other side. This completes the cable installation.

4.1.2 TWISTED-PAIR CONNECTION USING RJ-11 OR RJ-45

The RJ-11 and RJ-45 connectors on the Converter's twisted-pair interface are pre-wired for a standard telco wiring environment. The signal/pin relationships are shown in **Figure 4-9**.

<u>RJ-11</u>	<u>Signal</u>	<u>RJ-45</u>	<u>Signal</u>
1	————GND ¹	1	————N/C
2	————RCV-	2	————GND ¹
3	————XMT+	3	————RCV-
4	————XMT-	4	————XMT+
5	————RCV+	5	————XMT-
6	————GND	6	————RCV+
		7	————GND
		8	————N/C

¹Connection to ground is optional.

Figure 4-9. Signal/Pin Relationships.

<u>Signal</u>	<u>Pin#</u>	<u>Pin#</u>	<u>Signal</u>
GND ¹	1	6	GND ¹
RCV-	2	4	XMT-
XMT+	3	5	RCV+
XMT-	4	2	XMT+
RCV+	5	3	XMT+
GND ¹	6	1	GND ¹

¹Connection to ground is optional.

Figure 4-10. RJ-11 Cable (4-wire).

<u>Signal</u>	<u>Pin#</u>	<u>Pin#</u>	<u>Signal</u>
GND ¹	2	7	GND ¹
RCV-	3	5	XMT-
XMT+	4	6	RCV+
XMT-	5	3	RCV-
RCV+	6	4	XMT+
GND ¹	7	2	GND ¹

Figure 4-11. RJ-45 Cable (4-wire).

<u>Signal</u>	<u>Pin#</u>	<u>Pin#</u>	<u>Signal</u>
XMT+	3	3	XMT+
XMT-	4	4	XMT-

Figure 4-12. RJ-11 Cable (2-wire).

<u>Signal</u>	<u>Pin#</u>	<u>Pin#</u>	<u>Signal</u>
XMT+	4	4	XMT+
XMT-	5	5	XMT-

Figure 4-13. RJ-45 Cable (2-wire).

4.2 Wiring for Multipoint Circuits

The Converter supports multipoint applications using a daisychain topology. This topology requires special wiring, as well as specific DIP-switch settings for master and slave units. Refer to **Table 3-3** for multipoint DIP switch settings.

DAISYCHAIN TOPOLOGY

Using a daisychain topology, you may connect several Converters together in a master/slave arrangement. Maximum distance between the units will vary based upon the number of drops, data rate, wire gauge, etc. Call Technical Support for specific distance estimates.

Figure 4-14 shows how to wire the two-pair cables properly for a Converter daisychain topology.

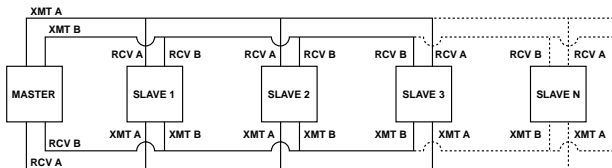

Figure 4-14. Daisychain wiring for the Converter host and slaves.

4.3 Connection to the EIA/TIA-574 Interface

The Converter is designed to plug directly into the DB9 serial port of an EIA/TIA-574 DTE device (PC, laptop, host). If you must use a cable to connect the Converter to the DTE device, make sure that it is a straight-through cable of the shortest possible length—we recommend 6 ft. (1.8 m) or less. The DB9 connector on the Converter is wired according to the EIA/TIA-574 Standard, as shown in **Figure 4-15**.

<u>DB9</u>	<u>Signal</u>
1	CD
2	RD
3	TD
4	DTR
5	SG/FG
6	DSR
7	RTS
8	CTS
9	(Optional 6-12 VDC)

Figure 4-15. EIA/TIA-574 Standard.

NOTE

The Converter is configured as a DCE, and is therefore designed to connect to a DTE. If you need to connect the Converter to another DCE device, call technical support for details about the proper crossover cable.

4.4 Operating the Converter

Once the Converter is properly installed, it should operate transparently—as if it were a standard cable connection. Operating power is derived from the RS-232 data and control signals; there is no ON/OFF switch. All data signals from the RS-232 and RS-485 interfaces are passed straight through. One hardware flow-control signal is also passed in each direction (see the last bullet point in **Section 2.2** for an explanation).

Appendix: EIA/TIA-574 Interface

<u>DB9</u>	<u>Signal</u>	<u>Direction</u>
1	CD	Output
2	RD	Output
3	TD	Input
4	DTR	Input
5	SG/FG	_____
6	DSR	Output
7	RTS	Input
8	CTS	Output
9	Optional 6-12 VDC	



© Copyright 1998. Black Box Corporation. All rights reserved.

1000 Park Drive • Lawrence, PA 15055-1018 • 724-746-5500 • Fax 724-746-0746